



TOOLS FOR ASSEMBLER- MODULAR FURNITURE - FFS/Q5101**संयोजनकर्ता मॉड्यूलर फर्नीचर**

S.NO.	TOOLS	IMAGE OF TOOLS	QUANTITY
PORTABLE POWER TOOLS MACHINES पोर्टेबल पावर टूल्स मशीन			
1	ELECTRIC PLANER इलेक्ट्रिक प्लेनेर		5 PCS
2	ELECTRIC ROUTER WITH BITS राऊटर		5 PCS
3	ELECTRIC CIRCULAR SAW इलेक्ट्रिक सरकुलर हेन्ड सॉ		5 PCS
4	SANDING MACHINE सैं डंग मशीन		5 PCS
5	ELECTRIC DRILL RIVEL/ SIVEL इलेक्ट्रिक ड्रिल		5 PCS

6	JIGSAW MACHINE जिग साँ मशीन		5 PCS
<u>PERSONAL PROTECTIVE EQUIPMENT (PPE) निजी सुरक्षात्मक उपकरण</u>			
1	EAR PROTECTOR एयर प्रोटेक्टर		10 PCS
2	FACE MASK फेस मास्क		10 PCS
3	SAFETY GOGGLES गॉगल्स		10 PCS
4	SAFETY SHOES सेफ्टी शूज		30 PAIRS



PLAINING TOOLS रन्दाई के औजार

1	SMOOTHING PLANE (10 INCH) गुटका रन्दा / स्मूथिंग प्लेन		5 PCS
2	GROOVE PLANE प्लो प्लेन (झरी रन्दा)		5 PCS
3	REBATE PLANE (8 INCH) पतामी रन्दा		5 PCS



STRIKING TOOLS चोट मारने वाले औजार

1	CROSS PEEN HAMMER क्रॉस पीन हथौड़ी		10 PCS
2	MALLET मैलेट		10 PCS
3	SOFT HAMMER सॉफ्ट हैमर		5 PCS

SAWING TOOLS लकड़ी को चीरने वाले औजार

1	HAND SAW हैंड साँ		10 PCS
2	HACK SAW हैक्स साँ		5 PCS
3	KEY HOLE SAW की होल साँ		5 PCS

MEASUREMENT TOOLS मापने के औजार

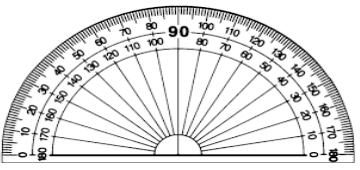
1	STEEL RULE स्टील रूल		30 PCS
2	STEEL TAPE (5 METER) स्टील टेप		30 PCS
3	PROTRACTOR प्रोटेक्टर		30 PCS

MARKING TOOLS निशान लगाने के औजार



1	PENCIL – 4HB पें सल		30 PCS
---	-------------------------------	--	--------









2	MARKING THREAD OR CHALK LINE मे कंग थ्रेड या चाक लाइन		15 PCS
3	MARKING GAUGE मा कंग गेज		10 PCS
4	MARKING KNIFE (UTILITY) मा कंग नाइफ		10 PCS
TESTING TOOLS जाँच करने वाले औजार			
1	TRY SQUARE गुनिया		20 PCS
2	MITRE SQUARE माइटर गुनिया		20 PCS
3	PLUM BOB प्लम्ब बॉब (साहुल)		20 PCS
4	SPIRIT LEVEL स्परिट लेवल		20 PCS

CHIPPING TOOLS छीलने के औजार



1	FIRMER CHISEL (3/4",1" ,1 1/2") फरमर चोरसी		10 PCS EACH
2	BEVEL CHISEL (3/4",1" ,1 1/2") बैवल चोरसी		10 PCS EACH
3	PARING CHISEL लम्बी चोरसी		10 PCS EACH
4	CHOPPING CHISEL चौड़ी चोरसी		10 PCS EACH
5	MORTISE CHISEL (6MM, 12 MM) मोर्टाइज चोरसी		10 PCS EACH

HOLDING TOOLS पकडने वाले औजार / कसने वाले

1	BENCH VICE बेन्च वाइस		5 PCS
2	T BAR CRAMP (5 FOOT) टी बार शेश क्रेम्प		3 PCS







3	G CRAMP (4 INCH) जी क्रेम्प		10 PCS
<u>BORING TOOLS</u> सुराख करने वाले औजार			
1	HAND DRILL हैंड ड्रिल		3 PCS
2	FLAT DRILL BITS फ्लैट ड्रिल बिट		5 PCS EACH
3	CENTER DRILL BIT (KIT) सेन्टर ड्रिल बिट		10 KIT SET
4	EXPANSION BITS एक्सपेंशन बिट		10 PCS
5	DRILL BIT (35MM) FOR AUTO CLOSING HINGES कनसील्ड हिन्ज बिट		10 PCS
<u>FILING TOOLS</u> फाइलिंग औजार			
1	RASP FILES रास्प फाइल		5 PCS
2	TRINGLUR FILE (4 INCH) ट्रिंगुलेर फाइल (टिकोरा)		20 PCS

3	FLAT FILE 6 INCH (3 -12 MM) फलैट फाइल		5 PCS
4	HALF ROUND FILE (6 INCH and 10 INCH) (3-12 MM) हाफ राउंड फाइल		5 PCS
5	ROUND FILE (5 INCH & 6 INCH), (3-1 2 MM) राउंड फाइल		5 PCS
<u>MISCELLANEOUS TOOLS</u> मले जुले औजार			
1	PINCER पंसर (जमूर)		5 PCS
2	PLIER (8 INCH) प्लायर		10 PCS
3	NAIL PUNCH नेल पंच		5 SET
4	CENTRE PUNCH सेंटर पंच		5PCS
5	SCREW DRIVER (RERVERSIBLE +/-) स्कू ड्राइवर		30 PCS

6	ALLEN KEY SET एल एन की सैट		10 SET
7	OIL STONE (CARBURANDUM) आयल स्टोन		10 PCS
8	SAND AND EMERY PAPER (DIFFERENT TYPES) सैंड और एमरी पेपर		10 PCS

HARDWARE FOR LEAD ASSEMBLER हार्डवेयर समाग्री

1	POZIDRIVE COUNTERSUNK SCREW (3.5 X 16), (4 X 20) पोजीड्राइव काउंटरसंक पैच		100 PC EACH
2	SILENT HINGES (FOR CABINET- 0 CRANK, 9.5 CRANK, 16 CRANK) साइलेंट हिंजेस		10 PAIRS EACH
3	165° HINGE (FOR CORNER CABINETS) कार्नर हिंजेस		10 PAIRS
4	FR ROLLER BASED BOTTOM MOUNTED RUNNER बॉटम माउंटेड रनर		10 SETS

5	TELESCOPIC RUNNER SIDE MOUNTED (20 INCH) टेलीस्को पक रनर		10 SETS
6	BOTTOM MOUNTED CONCEALED RUNNER SILENT SYSTEM (20 INCH) बॉटम माउंटेड रनर		10 SETS
7	DRAWER WITH SIDE WALL WITH SILENT UNDERMOUNT RUNNER (18 INCH AND 20 INCH) दराज रनर साइड वाल के साथ		5 SETS
8	WIRE BASKETS (SIZE HT 100 MM, 150 MM & 200 MM WITH DEPTH 500 MM) (20 INCH) वायर बास्केट		5 PCS
9	RASTEX/ MINIFIX रेसटेक्स /मनी फ़क्स		100 PCS
10	DOWEL FOR RASTEX/ MINI FIX डोवेल		100 PCS

11	VB FITTINGS (35 MM - PLASTIC OR METAL WITH DOWEL) वी बी फटिंग		100 PCS
12	CONNECTING SCREW (PLASTIC/ METAL) कनेक्टिंग स्कू		100 PCS
13	SUSPENSION BRACKET (FOR OVERHEAD CABINETS) सस्पेंशन ब्रैकेट		20 PCS
14	RAIL FOR SUSPENSION BRACKET (FOR OVERHEAD CABINETS) ससपेन्शन ब्रैकेट रेल		20 PCS
15	SHELF PINS (FOR GLASS AND WOODEN SHELF) सेल्फ पन		ASSORTED 100 PCS
16	PVC LEGS WITH CLIPS (100 MM) पी वी सी लेग		20 PCS
17	PLY BOARD (8X4 FEET 18MM & 8X4 FEET 12 MM) प्लाई बोर्ड		3 PCS EACH

18	MDF BOARD (8X4 FEET 18MM & 8X4 FEET 12 MM) एमडीएफ बोर्ड		3 PCS EACH
19	SUNMICA LAMINATE (1 MM, 0.8 MM) सनमाइका	ANY COLOUR	5 PCS EACH
20	ADHESIVE/GLUE (FOR MICA & EDGE BANDING) एडहे सव	ANY BRAND	5 KG
21	EDGE BANDING TAPE (2 MM, 1.3 MM & 0.8 MM) एज बैं डंग टेप	ANY COLOUR	50 MTR EACH